

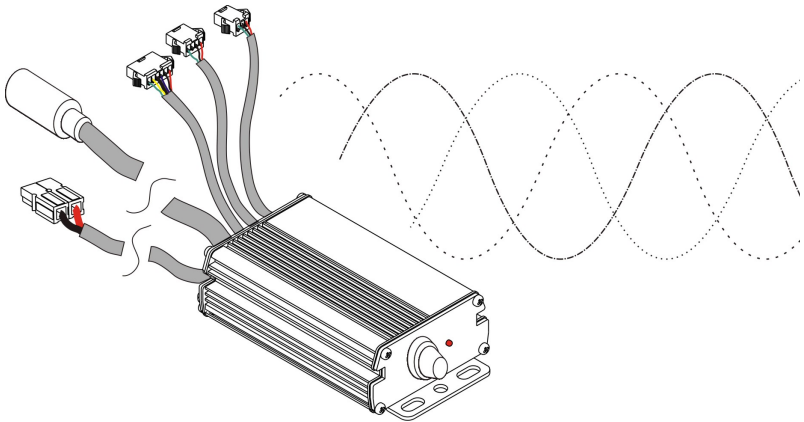

# 20A SineWave Grinfineon Motor Controller

## *Higo Motor Plug for Small Hubs*

User Manual - Rev 2.2



**Grin Technologies Ltd**  
Vancouver, BC, Canada

ph: (604) 569-0902  
email: [info@ebikes.ca](mailto:info@ebikes.ca)  
web: <http://www.ebikes.ca>

**Copyright © 2018**

## Table of Contents

<b>1</b>	<b><i>Introduction</i></b> .....	<b>3</b>
1.1	Key Features.....	3
<b>2</b>	<b><i>Installation and Hookup</i></b> .....	<b>4</b>
2.1	Basic Hookup.....	5
2.2	Cycle Analyst Hookup.....	7
2.3	V3 Cycle Analyst Hookup.....	8
<b>3</b>	<b><i>Core Features</i></b> .....	<b>9</b>
3.1	Silent Sine Wave Mode.....	9
3.2	LED Indicator.....	9
3.3	On/Off Button.....	10
3.4	Regenerative Braking via Ebrake.....	10
3.5	Proportional Regen via 0-0.8V Throttle Signal.....	10
3.6	Fwd / Rev.....	12
3.7	Fault Tolerant Hall.....	13
<b>4</b>	<b><i>Limitations</i></b> .....	<b>13</b>
4.1	Power Oscillations at Full Throttle when Sensored.....	13
4.2	eRPM Sensorless & Sensored.....	14
4.3	No Change to Internal Settings.....	15
4.4	Won't Show CA Accessory Current Draw.....	15
<b>5</b>	<b><i>Specifications</i></b> .....	<b>16</b>
5.1	Electrical.....	16
5.2	Mechanical.....	16
5.3	Connector Pinout.....	16

## 1 Introduction

The Grinfineon Sine Wave controller is based around the popular Xie Chang device with the XCKJ3232C control chip, but with custom firmware to allow both sensed and sensorless operation and proportional regenerative braking. The generous cable harness lengths, crimpable connector standard and popular Z910 Higo phase plug in this model make it broadly useful in aftermarket and DIY ebike applications for geared or direct drive hub motors in the 250-500 watt nominal power range.

### 1.1 Key Features

Here are some of the features that make this controller stand out which you won't usually find with most 3<sup>rd</sup> party ebike motor controllers

- Long phase leads (90 or 115cm) with 9 Pin Higo Connector
- On/Off Button with Waterproof Boot
- Pass-Thru of Motor Speed Sensor to Cycle Analyst Plug
- Dual Mode, works With and Without Hall Sensors
- Sine Wave Operation in Sensed Mode
- High Sensorless eRPM Compatible with Most Geared Motors
- LED Status Indicator
- Watertight Enclosure
- Compatible with V2 and V3 Cycle Analysts
- User Crimpable JST-SM Signal Connectors

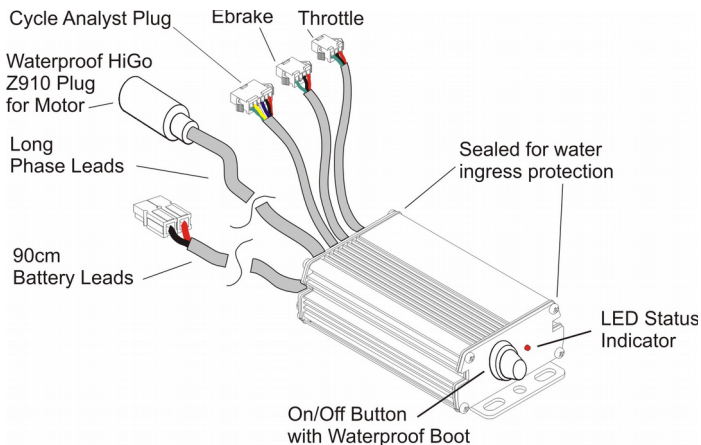

**Figure 1: Key Controller Hardware Features**

## 2 Installation and Hookup

The motor controller end plates have a flange with holes to facilitate securing to the vehicle. We recommend locating it in place where the ON/OFF switch is accessible and where it still has good exposure to air flow. Common bicycle locations include on the front of the rear rack support, between the seat tube and the rear wheel, or on the top tube with front motors.

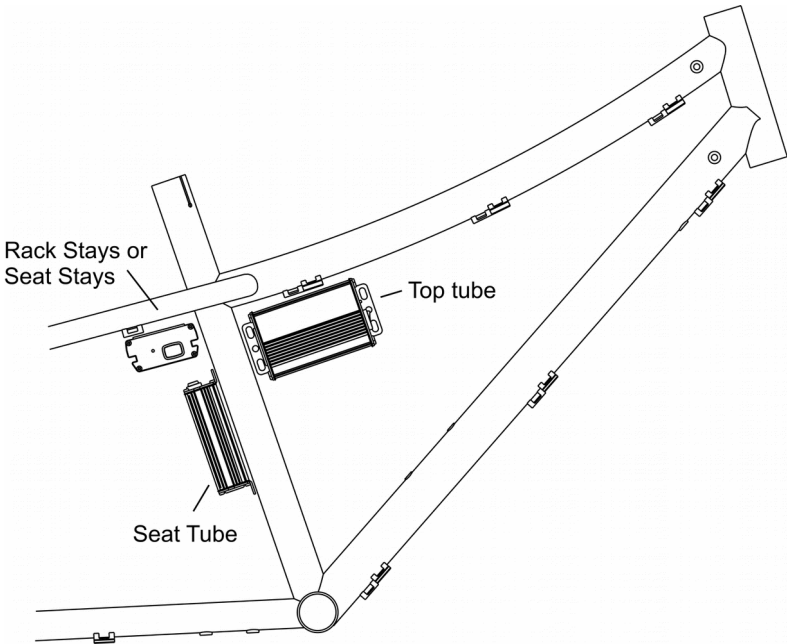
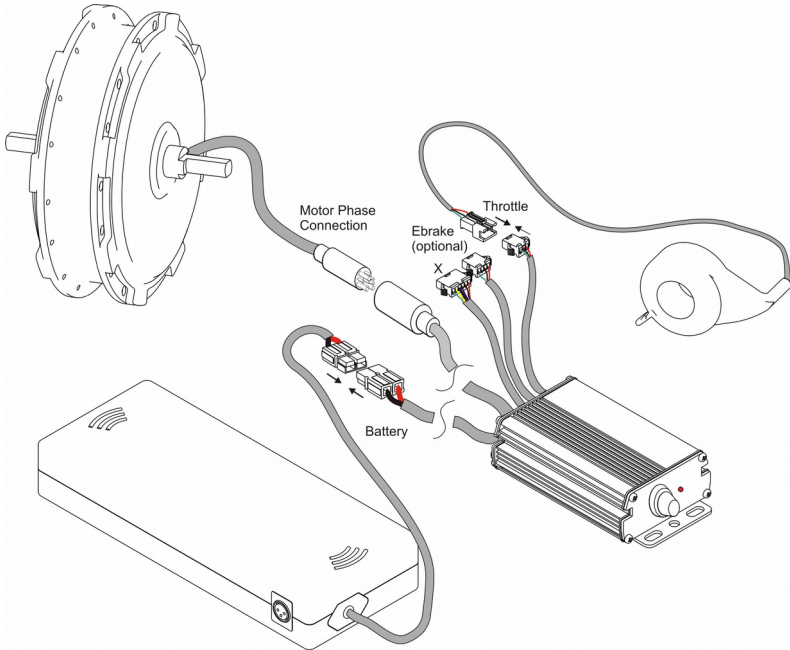

**Figure 2: Common mounting locations and orientations**

It is also possible to mount the controller inside a bag or enclosure box to look more discrete, but the lack of passing air flow will make it more susceptible to overheating in this arrangement. The silicone grommets on the controller end plates do an excellent job of keeping water out, so there is little concern about having the controller exposed to the elements, and the orientation of the installed controller does not matter.

## 2.1 Basic Hookup

The controller has 5 cables coming out of it: Battery, Motor, Throttle, Ebrake, and Cycle Analyst. At the bare minimum, the controller just needs a throttle, battery pack, and motor connection in order to work:



**Figure 3: Basic hookup diagram (motor, throttle, and battery)**

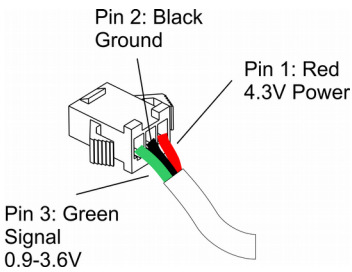

**Figure 4: Controller Throttle Pinout**

The throttle is a 3-pin JST-SM plug intended for Hall Effect throttle devices. It supplies 4.3V to power the throttle plug and expects a signal of 0.9V - 3.6V as the throttle is twisted. Throttle signal voltages higher than 4.0V are considered a fault condition, so if a potentiometer based throttle is used then appropriate resistors are needed to keep the voltage swing within range.

The brushless hub motor should have a matching 9-pin Z910 Higo plug, with 3 larger phase wire pins and 6 smaller signal wires. Five of those signal wires are used for the hall sensor, and the 6<sup>th</sup> is used as the speed indicator for the Cycle Analyst device, eliminating the need for an external spoke magnet and speedometer sensor.

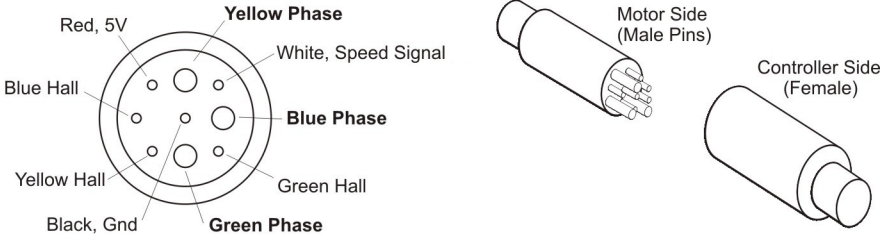

**Figure 5: Higo Z910 Controller Pinout (Female Side).** The extra white signal wire is used for speedometer line with geared hub motors.

The internal pinout of the phase and signal wires should be consistent with almost any Bafang (aka 8Fun) motor or their clones, as the different manufacturers have done a good job of standardizing on this connector. Because of this it is a reasonable bet that a given 3<sup>rd</sup> party hub motor with the Higo Z910 plug on it will be plug and play, but we can't of course guarantee that.

If the motor does not turn properly, spins in reverse, or just growls, then it means the hall and phase pins are not consistent. The easiest remedy in this situation is to open up the controller and internally disconnect the 3 hall signal wires which you will find attached with a 3-pin JST-SM Plug. This then allows the controller to run sensorless.

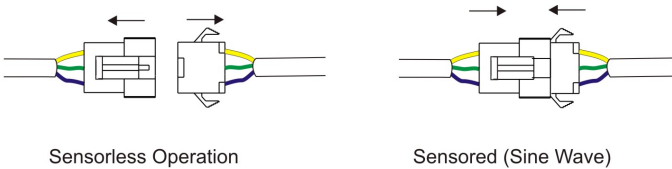

**Figure 6: Internal Hall Plug.** Inside controller hall wires can be connected or unplugged to change between sensed and sensorless operation

You can connect an ebrake lever to the 4-pin plug if you want ebrake cutoffs. With geared motors the controller will momentarily do regenerative braking but



experiment with trial and error to determine how many speed pulses your wheel produces and put this in the #poles setting of the Cycle Analyst setup menu.

### 2.3 V3 Cycle Analyst Hookup

Finally, if you are using a V3 Cycle Analyst, then your throttle and ebrake signals will connect to the Cycle Analyst rather than to your motor controller. Only the 6-pin CA-DP plug of the controller is used.

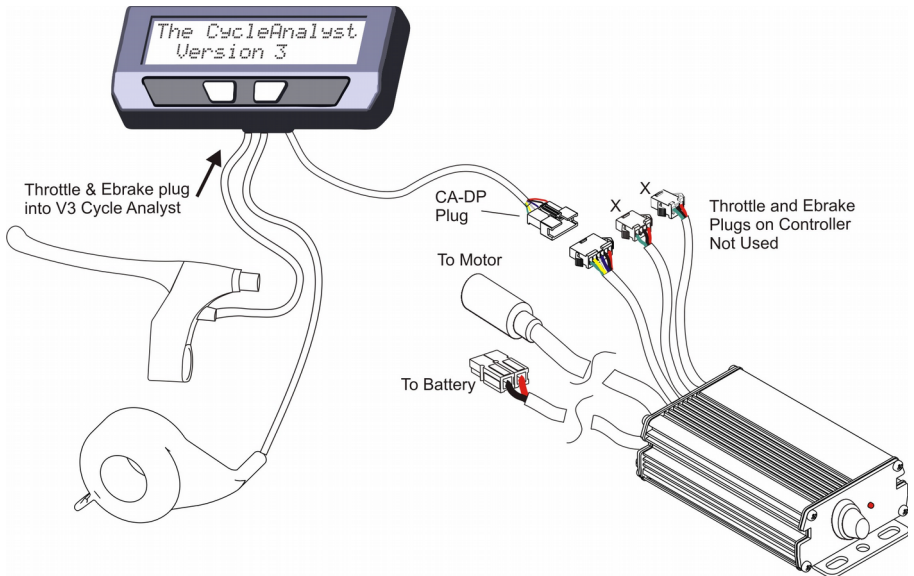

**Figure 8: CA V3 Hookup. Throttle and eBrake Plug into CA (not controller)**

The V3 Cycle Analyst hookup can be clean and simple with only a single cable going from the handlebar to the motor controller. Since the throttle signal is intercepted by the CA before going to the controller, many more advanced control features are possible in this arrangement. That includes features like PAS assist, custom throttle mapping, motor over-temperature protection, torque sensing pedelec, mode presets etc.



## 3 Core Features

### 3.1 Silent Sine Wave Mode

When the controller has hall sensors connected, the 3 phase output drive waveform is sinusoidal rather than trapezoidal. On most direct drive hub motors, this means a butter smooth feeling as you apply the throttle rather than the normal buzz or growl you may be used to. And even on geared motors the audible sound from the hub can be noticeably reduced.

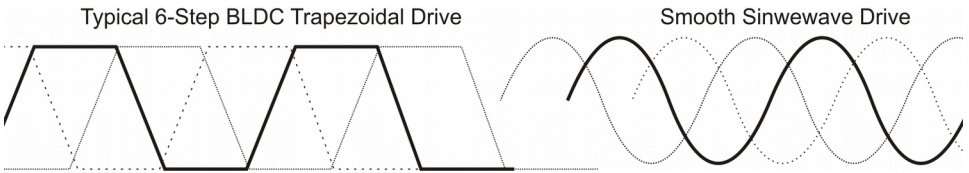

Figure 9: Illustration of Voltage Waveform of Trapezoidal vs Sine Wave Outputs

### 3.2 LED Indicator

The LED status indicator lets you know if the controller is powered up, what state it's in, and most importantly if there are any fault conditions that would cause things not to work. The following are normal operating modes:

LED Off	No power to controller (either battery is disconnected, or ON/OFF switch is OFF)
LED Slow Flash	Controller powered up, throttle is not pressed or it is running but in sensorless mode
LED Steady On	Controller is running the motor in sensed mode

The following state flash signals occur with quick blinks and then a pause. Note though that in sensorless mode, the error flash codes may not be visible due to the regular blinking that happens when running sensorless:

3 Blinks	Controller is in over voltage fault or has damaged MOSFETs
4 Blinks	Battery voltage below low voltage cutoff
5 Blink	Brake cutoff is engaged
6 Blinks	Throttle either too high or engaged when controller turned on

### 3.3 On/Off Button

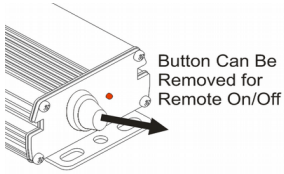

**Figure 10: On Off Switch Details**

The included ON/OFF button on the controller end plate allows you to switch your ebike on and off without disconnecting the main battery pack. When the switch is off, both the Controller and the Cycle Analyst (if attached) will power down and cease drawing current from the battery.

### 3.4 Regenerative Braking via Ebrake

The Grinfineon controllers have regenerative braking capabilities, allowing you to use the hub motor as a brake and return kinetic energy back into the battery pack. Since the majority of small motors with Higo Z910 plug are geared hubs this regen feature won't serve much use, but in the event of a user either locking the freewheel on their motor or using this controller with a direct drive hub, it could prove valuable.

Regen is achieved either with the ebrake lever for a constant 50% braking force, or with a 0.0 to 0.8V throttle signal for variable 0-100% braking.

In the first method, you connect an ebrake cutoff lever or other momentary switch between pins 2 and 4 of the 4-pin ebrake plug (Pin 1 = 4.3V power is useful for powering Hall Effect ebrake cutoffs). When the ebrake signal is pulled to ground, then the controller switches to a baseline level of regenerative braking, putting drag on the wheel and a small amount of current in the battery pack.

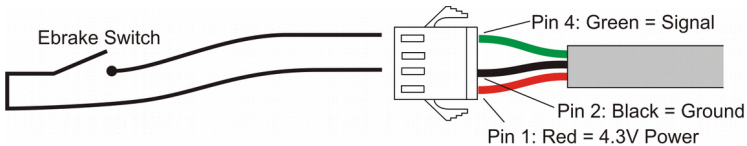

**Figure 11: eBrake Connector. 5V+ for Hall Brakes**

The intensity of this regenerative braking torque is fixed at about 50% of max regen, and is not affected by applying the throttle.

### 3.5 Proportional Regen via 0-0.8V Throttle Signal

The second method to engage regen is with a throttle signal that is less than 0.8 Volts. Normally a hall effect throttle will only swing from 0.9V to about 3.6V, leaving the range of 0.0-0.9V unused. In the Grinfineon controllers, this unused range is mapped to regenerative braking, with regen starting below 0.8V and

then increasing to a maximum as the throttle signal goes down to 0.0V. This can be seen in the graph below showing the torque measured from a hub motor as the throttle signal is swept from 0.0V to 4.0V.

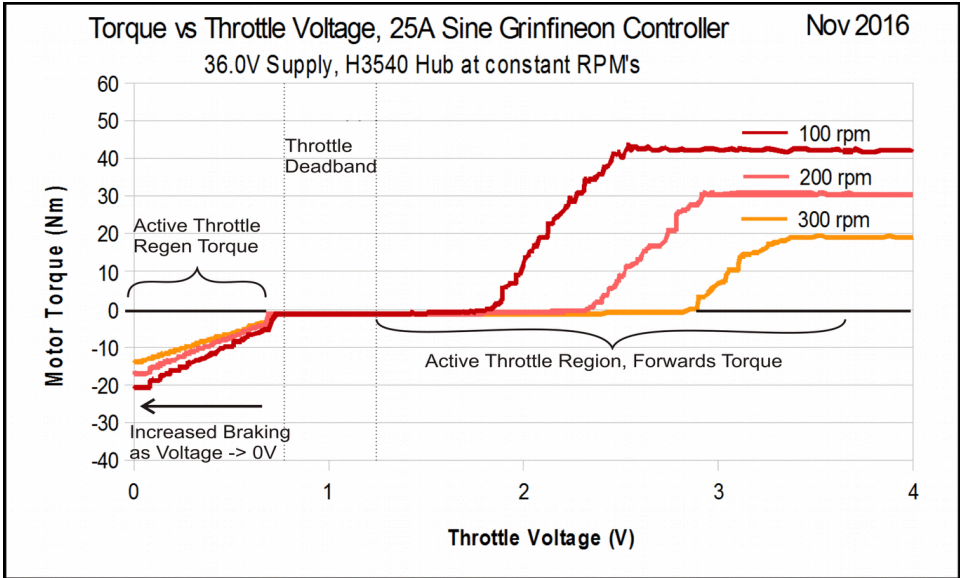
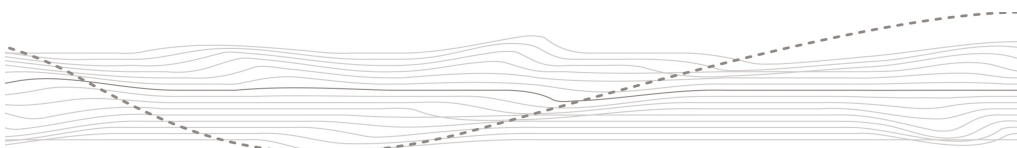

**Figure 12: Regen intensity for throttle 0V-0.8V**

The test was done with the motor spinning at 100, 200, and 300 rpm. You can see that at lower RPMs, the braking intensity was higher for a given throttle voltage.

Even though the regenerative braking intensity is reduced at higher speeds, the actual regen current flowing into the battery pack increases at high speeds as there is more mechanical power being converted into electrical energy.

You can see this relationship clearly in Figure 13, which shows both the torque and the amperage flowing back into the battery at 4 different levels of throttle regen (0.0, 0.2, 0.4, and 0.6V) versus the motor RPM. It also shows how much regen current and braking force you can expect from the fixed ebrake input switch, which is shown by the dashed black lines.



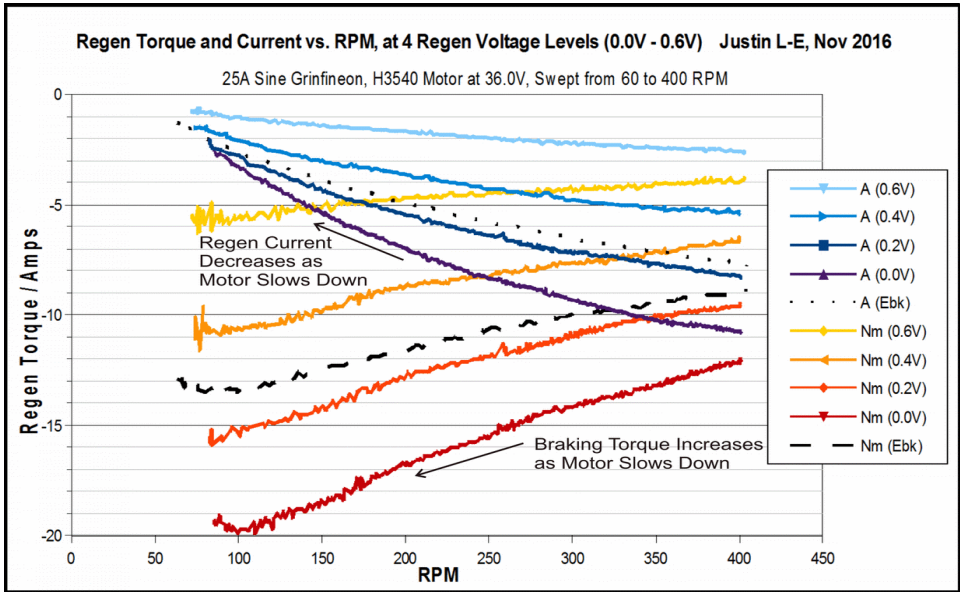
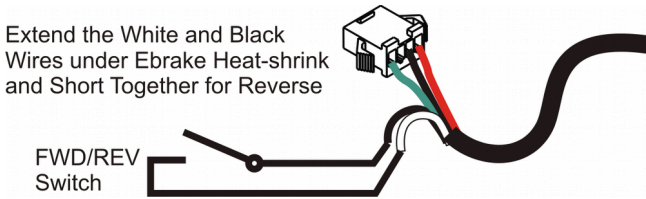

**Figure 13: Regenerative Braking Torque and Current as a Function of Motor RPM at 4 different throttle regen voltages and also with ebrake lever pressed (Ebk, dashed lines)**

This throttle mapped regen is handy since it allows for variable braking without any additional wires to the controller, and in principle a small bidirectional throttle would allow you to both accelerate and slow down without the need for any kind of brake sensors. It is also how regenerative braking is activated with the V3 Cycle Analyst, which can send any voltage signal to the throttle line.

### 3.6 Fwd / Rev

If you have an application where the motor direction needs to be reversed at times, as is handy with trike and quad applications, then there is an additional white forwards/reverse direction wire that is tucked under the ebrake heatshrink. If this wire is exposed and then connected via a switch to the adjacent black ground wire, it will enable you to change the motor direction on the fly without swapping the motor phase and hall leads.



**Figure 14: FWD/REV, Remove heatshrink tubing over ebrake connector to expose spare white and black signal wires, and extend those to your reverse switch.**

### 3.7 Fault Tolerant Hall

Normally a sensed motor/controller setup is somewhat vulnerable to damage of the hall sensor itself, the hall wires, or the hall connector pins. If this happens, the motor will run very rough or not at all. On the Sine Wave Grinfineon controllers, the control logic will still be able to operate in sensed sine wave mode even if one of the hall sensors is damaged as it can interpolate the missing signal. However, the initial starting can be a bit rough, and the ebrake input no longer does regenerative braking but just does a controller cutoff.

## 4 Limitations

Although we tried to make this controller fairly universal, there are also more than a few limitations that can affect its use in some applications.

### 4.1 Power Oscillations at Full Throttle when Sensed

In sensed sine wave mode, the motor controller is always attempting to interpolate the exact motor position at any given moment in between hall sensor events.

With certain geared hub motor installations, the controller can be prone to having large power fluctuations at full throttle while this interpolation overshoots and undershoots. This can be triggered by sudden changes in motor RPM (such as hitting a pothole or popping a wheelie) and it may require releasing and reapplying the throttle to smooth out.

If the motor setup is prone to this behavior, we recommend opening up the controller and unplugging the 3-pin JST connector that links the hall signals to the controller board. This will force the controller to operate sensorless, where this oscillation at full throttle is not an issue.

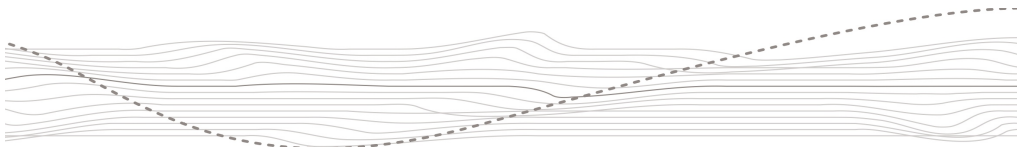

## 4.2 eRPM Sensorless & Sensored

The maximum commutation frequency in sensorless mode is about 28000 eRPM. This is substantially higher than previous Grinfineon controllers (13000 eRPM) and will work with most geared hub motors just fine at typical ebike speeds, but may still be an issue in very fast setups.

The electrical RPM is easy to calculate by taking the mechanical RPM of the motor, multiplying it by the number of magnetic pole pairs in rotor, and then again by the gear ratio if it is a geared hub.

For instance, Figure 15 is a diagram of a direct drive motor with 40 magnets. That means there are 20 magnetic pole *pairs*. A 28000 eRPM would correspond to a 1400 maximum mechanical RPM at the wheel, which is much faster than you would have on a bicycle (200-400 rpm is more common); therefore this hub would have no problem running sensorless at bicycle speeds.

The geared motor in Figure 15 has 32 magnets and a 7:1 gear reduction. In this case, the maximum speed in sensorless mode would be  $28000 \text{ eRPM} / 16 / 7 = 250 \text{ rpm}$ . In a 26" wheel that would correspond to 31 kph. Below this speed the bike run fine but any faster and the controller is liable to shut down in a fault mode.

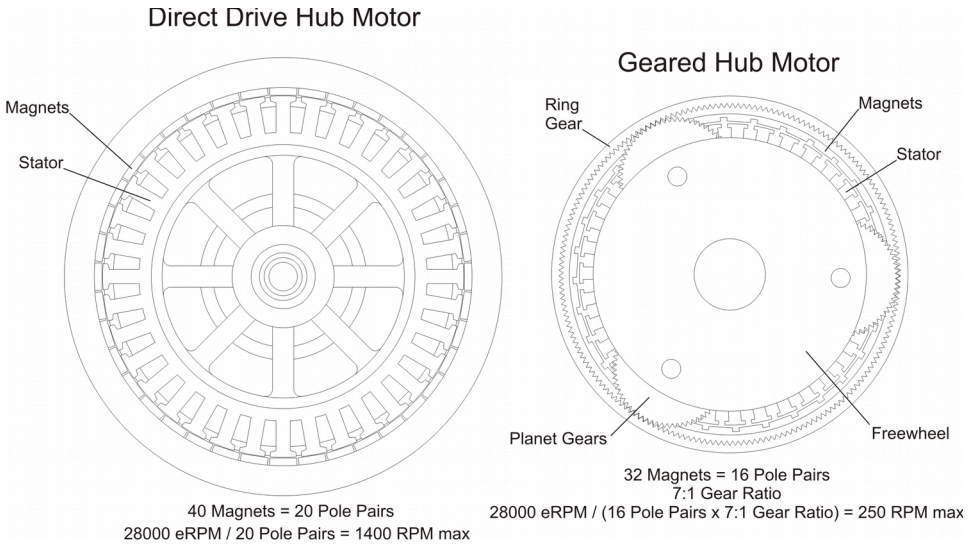

**Figure 15: Direct Drive and Geared Hub Motor eRPM examples**

The maximum speed when running with hall sensors is much higher, but at values over 50,000 eRPM the commutation timing can be off and motor performance will suffer.

### ***4.3 No Change to Internal Settings***

For a number of reasons the controller's internal settings for low voltage cutoff, battery and phase current limits, max regen current etc. are fixed in the controller IC and can't be reprogrammed by the user. The fixed values are sensibly chosen to be around the maximum allowable range for flexibility while keeping the controller in a conservative operating area.

If you want to further limit these settings for custom low voltage rollbacks or current/power limits, then either a V2 or V3 Cycle Analyst will provide that functionality and a lot more just via modulation of the throttle signal.

### ***4.4 Won't Show CA Accessory Current Draw***

The CA-DP plug on the motor controller is wired up so that it will show the current draw of the motor and controller, but not the current draw of any other devices (like front lights) that are plugged into the CA's power tap. If you want the Cycle Analyst to show auxiliary device current, then the controller can be opened up and the black wire from the CA-DP cable moved from the - side of the shunt (adjacent to the blue wire) to the + side of the shunt (adjacent to white wire).

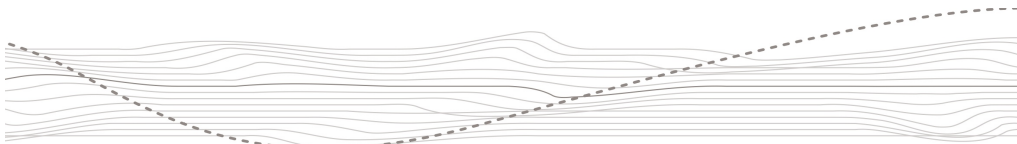

## 5 Specifications



### 5.1 Electrical

<b>Battery Current (+2% /- 10%)</b>	20 A
<b>Phase Current Limit (+/- 10%)</b>	50 A
<b>Nominal Battery Voltage</b>	36V-52V
<b>MOSFETs</b>	6x AOT460
<b>Max Regen Voltage (+/- 2%)</b>	58 V
<b>Low Voltage Cutoff (+/- 2%)</b>	27 V
<b>Control Chip</b>	XCKJ3232C
<b>eRPM Limit Sensorless</b>	~28,000

### 5.2 Mechanical

<b>Dimensions</b>	110x71x34 mm
<b>Weight</b>	0.47 kg
<b>Chassis Material</b>	Extruded Aluminum
<b>DC Battery Cable</b>	90 cm - Anderson Powerpoles
<b>Motor Cable</b>	90 or 115 cm - Higo Z910
<b>Other Signal Connectors</b>	15cm JST-SM Series
<b>Waterproofing</b>	Gasketed with Sealed Switch

### 5.3 Connector Pinout

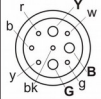
	<b>Throttle:</b> 1=4.3V 2=Gnd 3=Signal:1-3.6V
	<b>Ebrake*:</b> 1=5V 2=Gnd 3=NC 4=Ebrake
	<b>Cycle Analyst**:</b> 1=Vbatt 2=Gnd 3=-Shunt 4=+Shunt 5=Speed 6=Throt
	<b>Motor Plug (90-115cm):</b> Y,G,B = Motor Phases y,g,b,r,bk = Hall Signals and 5V w = Wheel Speed Sensor

**Figure 16: Connector Pinout Diagram**

Note that all signal wires just JST-SM series connectors with short ~15cm cable length.

\*White wire under heatshrink is Fwd/Rev input, jump to Gnd to enable

\*\*Use with old small screen Cycle Analyst devices may cause full throttle on plugging in, diode modification to green Throttle Override wire is required for proper operation.